

HYDROSEP C-90 6 m³ - 10L/S - NS200

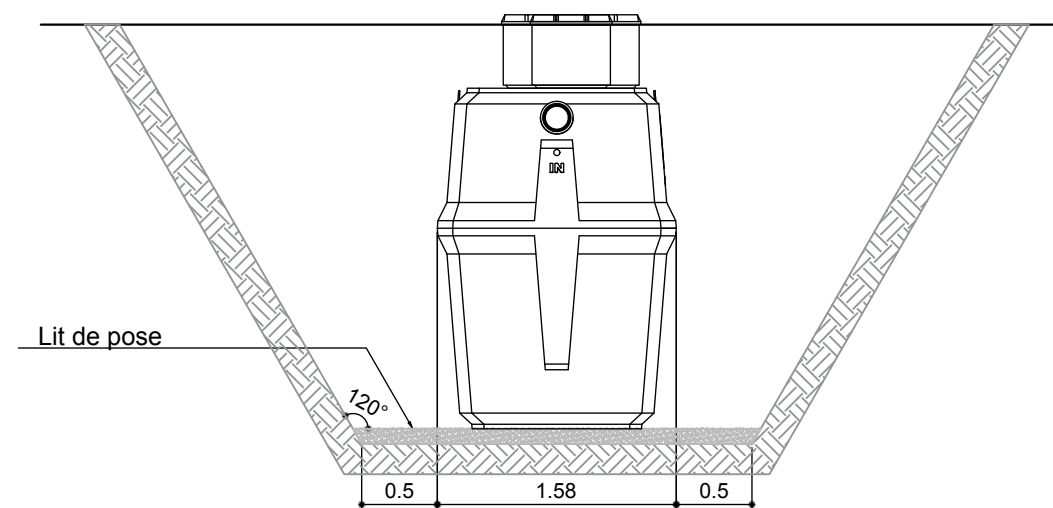
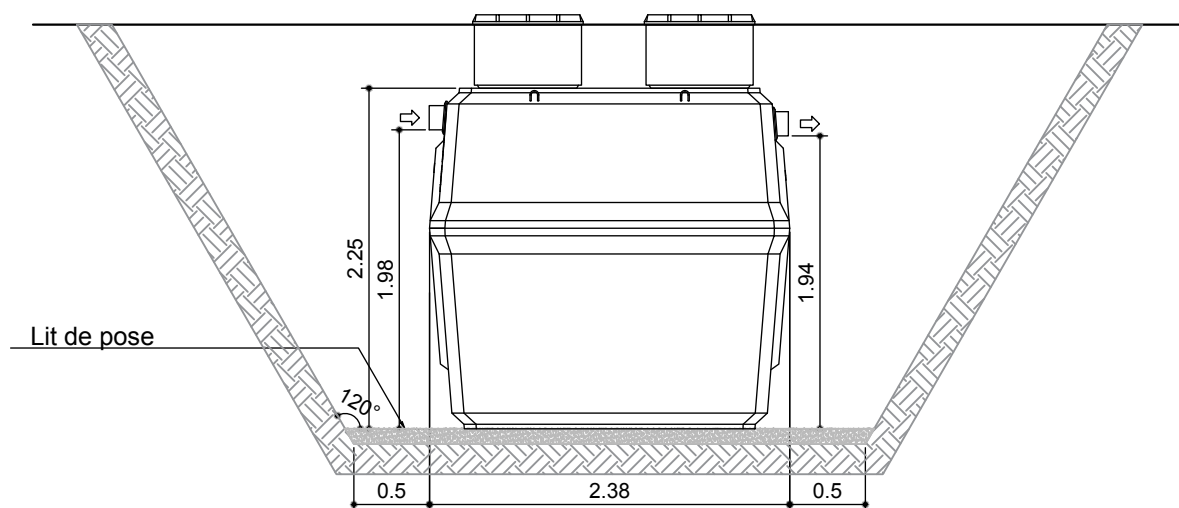
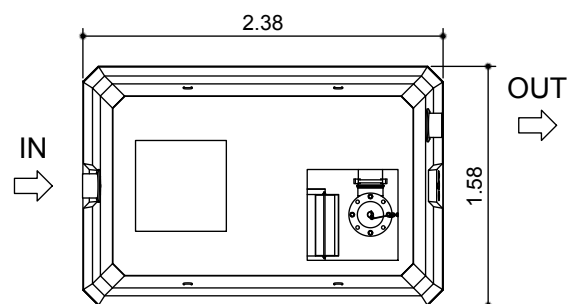

**REMARQUES:**

1. **Conditions de pose:**  
Merci de lire attentivement le guide de mise en œuvre avant toute installation !!
2. **Tolérances sur les dimensions:**  
2%
3. **Option(s):**  
Tuyauterie, rehausses, trappillons et accessoires en option.

DATE	INDICES	MODIFICATIONS	VALIDATION		
			Dressé par: P. Hick	Vérifié par: P. Doumen	Validé par: P. Wilmet

**eloy water**

Zoning de Damré, rue des Spinettes 13  
4140 Sprimont (BELGIUM)  
Tel: +32(0)4/382.44.00 - Fax: +32(0)4/382.44.01  
<http://www.eloywater.com> - [info@eloywater.com](mailto:info@eloywater.com)

**HYDROSEP C-90 6 m³ - 10 L/S - NS200**  
Monocuve  
Plan Guide d'Implantation

<b>GAMME STANDARD ELOY</b> HYDROSEP EUROPE	Echelles	Date	Feuille
	1/50	17/05/2018	A3
EW-1131		R 010 I001	