

Product: Grease trap

Type : Greastop® DEGWWC90
 Model : C-90 4.5m³ - 7 l/s

CHARACTERIZATION

Considered influent water :	Fat in wastewater
Nominal flow :	7 l/s
Volume of sludge storage :	1300 l
Volume of fat storage :	550 l

DIMENSIONS | VOLUMES | WEIGHT

Measure	Unit	
Total height* :	(cm)	185
Entry height* :	(cm)	148
Exit height* :	(cm)	141
Length :	(cm)	238
Width :	(cm)	158
Total volume :	(m ³)	4.73
Useful volume :	(m ³)	4.24
Weight :	(T)	2.50
Manhole :	(cm)	2 x Ø60
Ø IN / OUT :	(mm)	160/160

* tolerance ± 2 cm

Material

Tank : high performance fibre reinforced concrete
 Joints : SBR (in and out)

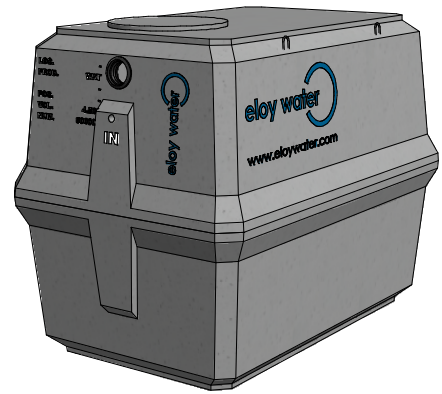

SIZING

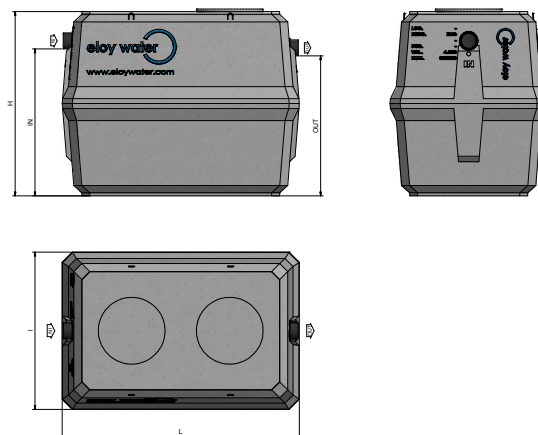

OPTIONS

- Odour cartridge

GUARANTEES

Tank : 10 years
 Accessories : 2 years
 Resistance : B125

Eloy Water reserves the right to modify, or more generally, to update this document at any time without prior notice.

Datasheet version: 20130703
 Product version: 20130410